



PDHonline Course G391 (1 PDH)

Common ADA Errors in Facilities Design

Instructor: Mark P. Rossow, Ph.D, PE Retired

2012

PDH Online | PDH Center

5272 Meadow Estates Drive
Fairfax, VA 22030-6658
Phone & Fax: 703-988-0088
www.PDHonline.org
www.PDHcenter.com

An Approved Continuing Education Provider

This document is a compilation of two documents from the U.S. Department of Justice:

1. "Common ADA Errors and Omissions in New Construction and Alterations," June 1997,
and
2. "Common ADA Problems at Newly Constructed Lodging Facilities,"
November 1999



Common ADA Errors and Omissions in New Construction and Alterations

Introduction

The ADA requires that new construction and alterations to existing facilities comply with the ADA Standards for Accessible Design¹ (Standards). ADA requirements for new construction and alterations include detailed provisions for elements, spaces, and facilities. Successful accessibility is often measured in inches, so attention to detail can make the difference between achieving access and excluding or injuring someone. When the ADA's minimum requirements are not met, the results can limit or exclude a person with a disability and can be dangerous. For example, when a curb ramp extends into an access aisle at an accessible parking space, a person using a wheelchair may not be able to get out of the car or van. When the slope of a sidewalk that is an accessible route becomes steeper than 1 to 20, railings and edge protection are

required for safe use. Objects that project into circulation spaces from the side or that do not provide at least 80 inches of head clearance can be extremely hazardous to people who are blind or who have low vision.

This document lists a sampling of common accessibility errors or omissions that have been identified through the Department of Justice's ongoing enforcement efforts. The specific requirement

of the Standards that has not been met follows each error/omission. All references to figures can be found in the Standards. The list of errors/omissions provides examples of common deficiencies. It is not intended to be comprehensive or exhaustive. Any

failure to comply with the Standards violates the ADA.

For additional information about the design and construction requirements of the Americans with Disabilities Act (ADA), contact the Department of Justice ADA Information Line. This free service provides answers to general and technical questions about ADA requirements and is a source for free ADA materials including the ADA Standards for Accessible Design. You may reach the ADA Information Line at:

800 - 514 - 0301 (voice) or
800 - 514 - 0383 (TTY).

ADA information is also available on the Department's ADA Home Page on the World Wide Web at (<http://www.usdoj.gov/crt/ada/adahom1.htm>).

Reproduction of this document is encouraged.

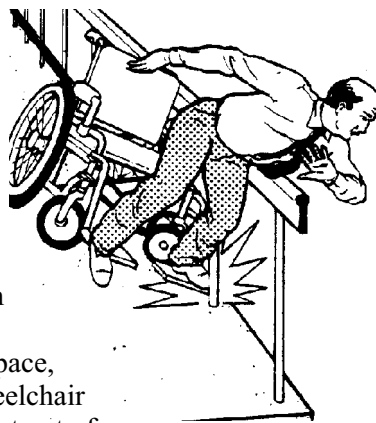

¹ State and local governments currently have the option to choose the Standards or the Uniform Federal Accessibility Standard (UFAS).

Parking

Error/Omission:

The built-up curb ramp projects into the access aisle.

The accessible parking space and access aisle is not level in all directions.

Result:

When an access aisle has a sloped surface, a wheelchair may roll away from a car or van preventing the wheelchair user from getting out of the vehicle. The sloped surface also prevents a van-mounted wheelchair lift from being fully-lowered to the access aisle surface.

Requirement:

4.6.3* Parking Spaces. ...Parking spaces and access aisles shall be level with surface slopes not exceeding 1:50 (2%) in all directions.

Error/Omission:

There is no accessible route from accessible parking to an accessible entrance.

Result:

A person using a wheelchair, scooter, or walker has no way of getting from the accessible parking space to the building entrance. Often when there is an inaccessible walkway provided for others, wheelchair users must use a roadway or vehicular route which can be dangerous.

Requirement:

4.6.3* Parking Spaces. ...Parking access aisles shall be part of an accessible route to the building or facility entrance and shall comply with 4.3.

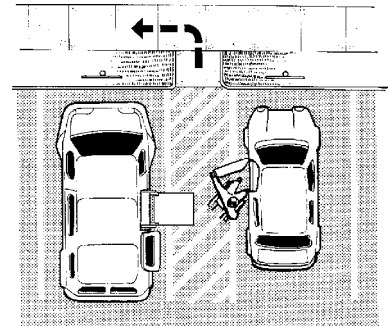

Error/Omission:

No van accessible spaces are provided in the parking area.

Result:

A person who uses a van equipped with a wheelchair lift has inadequate space to lower the wheelchair lift and get out of the vehicle.

Requirement:

4.1.2 (5)(b) One in every eight accessible spaces, but not less than one, shall be served by an access aisle 96 in (2440 mm) wide.

* Asterisk denotes that related, non-mandatory material is in the Appendix to the Standards.

Van-accessible (continued)

Requirement:

minimum and shall be designated “van accessible” as required by 4.6.4. The vertical clearance at such spaces shall comply with 4.6.5. All such spaces may be grouped on one level of a parking structure.

Accessible Route - Exterior

Error/Omission:

The pedestrian routes on a site from public transportation stops, accessible parking spaces, passenger loading zones, and public streets and sidewalks to the accessible entrance(s) are not accessible.

Result:

People with disabilities cannot travel from the site entry points to the accessible entrance(s). In some cases, people must use vehicular routes which can be dangerous.

Requirement:

4.1.2 (1) At least one accessible route complying with 4.3 shall be provided within the boundary of the site from public transportation stops, accessible parking spaces, passenger loading zones if provided, and public streets or sidewalks, to an accessible building entrance.

Curb Ramps

Error/Omission:

Curb ramp that is located across a circulation path has steep unprotected side flares.

Result:

People walking across the curb ramp may trip and be injured. People who use wheelchairs can tip over if they accidentally roll over the non-flared sides.

Requirement:

4.7.5 Sides of Curb Ramps. If a curb ramp is located where pedestrians must walk across the ramp, or where it is not protected by handrails or guardrails, it shall have flared sides; the maximum slope of the flare shall be 1:10 (see Fig. 12(a)). Curb ramps with returned curbs may be used where pedestrians would not normally walk across the ramp (see Fig. 12(b)).

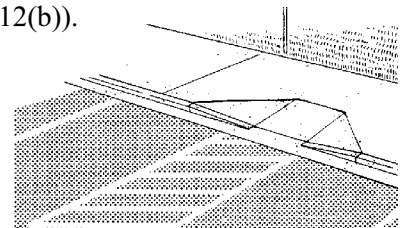

Ramps

Error/Omission:

Landing areas where ramps change direction (e.g., switchbacks or 90° turns) are too small.

Result:

Wheelchair users are unable to go up or down the ramp because there is not enough space to turn on a level surface. This makes the ramp unusable.

Requirement:

4.8.4* (3) If ramps change direction at landings, the minimum landing size shall be 60 in by 60 in (1525 mm by 1525 mm).

Error/Omission:

Parts of an accessible route with slopes that exceed 1:20 lack required features including handrails and edge protection.

Result:

When a walkway or other pedestrian surface has a slope greater than 1:20, it is more difficult to maintain control of a wheelchair. Wheelchair users may also not be able to climb up the sloped route without railings. Lack of edge protection may result in injury if a wheelchair user rolls off the side of the route. People who use a mobility device such as crutches, a cane, or a walker may lose their balance or fall while using a sloped section that does not have handrails or edge protection.

Requirement:

4.8.1* General. Any part of an accessible route with a slope greater than 1:20 shall be considered a ramp and shall comply with 4.8.

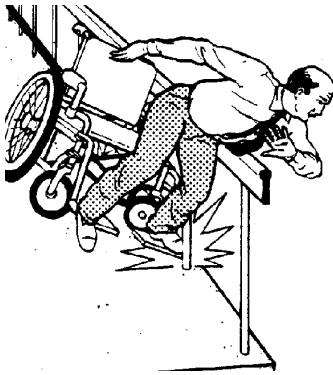

Stairs

Error/Omission:

Handrail extensions are not provided at the top and bottom risers.

Result:

People who use crutches or a cane or who have limited balance may fall at the top or bottom of the stairs because they have no railing to hold onto as they make the transition from the steps to the landing.

Requirement:

4.9.4(2) If handrails are not continuous, they shall extend at least 12 in (305 mm) beyond the top riser and at least 12 in (305

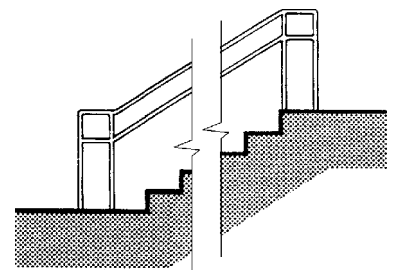

Stairs (continued)

Requirement:

mm) plus the width of one tread beyond the bottom riser. At the top, the extension shall be parallel with the floor or ground surface. At the bottom, the handrail shall continue to slope for a distance of the width of one tread from the bottom riser; the remainder of the extension shall be horizontal (see Fig. 19(c) and (d)). Handrail extensions shall comply with 4.4.

Doors

Error/Omission:

Adequate maneuvering clearance is not provided at doors, including doors to accessible toilet stalls.

Result:

A person using a wheelchair cannot open the door without a clear level area in front of and adjacent to the door that provides a place to maneuver.

Requirement:

4.13.6 Maneuvering Clearances at Doors. Minimum maneuvering clearances at doors that are not automatic or power-assisted shall be as shown in Fig. 25. The floor or ground area within the required clearances shall be level and clear.

4.17.5* Doors. Toilet stall doors, including door hardware, shall comply with 4.13. If toilet stall approach is from the latch side of the stall door, clearance between the door side of the stall and any obstruction may be reduced to a minimum of 42 in (1065 mm) (Fig. 30).

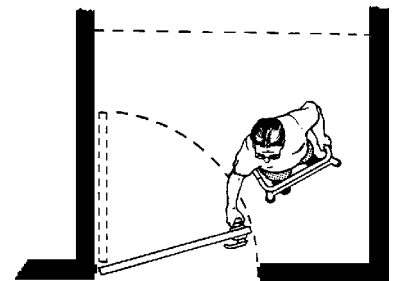
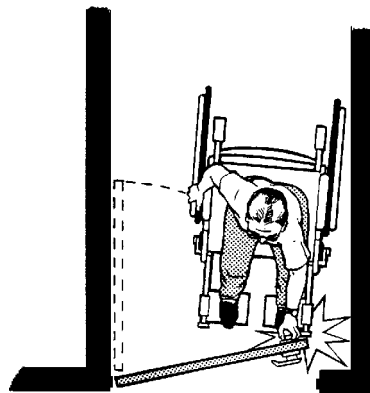

Error/Omission:

The shape of the door hardware requires tight grasping, pinching, and twisting of the wrist to use.

Result:

The door cannot be opened if the user cannot operate the latch or handle.

Requirement:

4.13.9* Door Hardware. Handles, pulls, latches, locks, and other operating devices on accessible doors shall have a shape that is easy to grasp with one hand and does not require tight grasping, tight pinching, or twisting of the

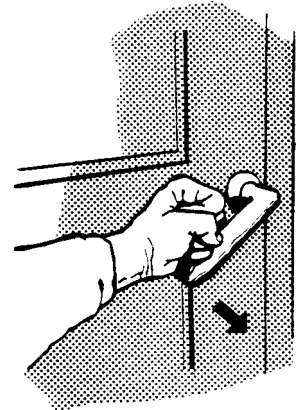

wrist to operate. Lever-operated mechanisms, push-type mechanisms, and U-shaped handles are acceptable designs. When sliding doors are fully open, operating hardware shall be exposed and usable from both sides. Hardware required for accessible door passage shall be mounted no higher than 48 in (1220 mm) above finished floor.

Circulation Paths



Error/Omission:

Objects protrude into circulation paths from the side or from posts.

Objects that overhang circulation paths do not provide clear headroom.

Circulation Paths (continued)

Result:

People who are blind or who have low vision can be seriously injured when they cannot detect an object by using the sweep of their cane.

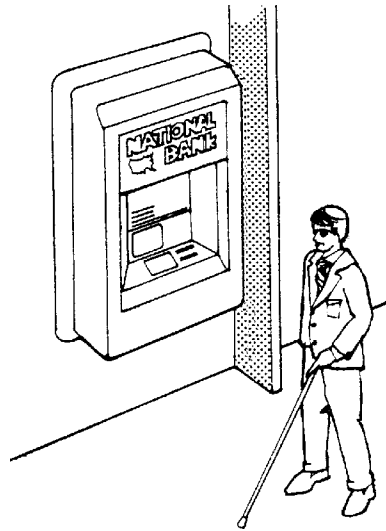

Requirement:

4.1.2 (3) All objects that protrude from surfaces or posts into circulation paths shall comply with 4.4.

4.1.3 (2) All objects that overhang or protrude into circulation paths shall comply with 4.4.

4.4.1* General. Objects projecting from walls (for example, telephones) with their leading edges between 27 in and 80 in (685mm and 2030 mm) above the finished floor shall protrude no more than 4 in (100 mm) into walks, halls, corridors, passageways, or aisles (see Fig. 8(a)). Objects mounted with their leading edges at or below 27 in (685 mm) above the finished floor may protrude any amount (see Fig. 8(a) and (b)). Free-standing objects mounted on posts or pylons may overhang 12 in (305 mm) maximum from 27 in to 80 in (685 mm to 2030 mm) above the ground or finished floor (see Fig. 8(c) and (d)). Protruding objects shall not reduce the clear width of an accessible route or maneuvering space (see Fig.8(e)).

4.4.2 Head Room. Walks, halls, corridors, passageways, aisles, or other circulation spaces shall have 80 in (2030 mm) minimum clear head room (see Fig. 8(a)). If vertical clearance of an area adjoining an accessible route is reduced to less than 80 in (nominal dimension), a barrier to warn blind or visually-impaired persons shall be provided (see Fig. 8(c-1)).

Toilet Rooms and Bathrooms

Error/Omission:

Where toilet rooms or bathrooms are provided, not all public and common use toilet rooms and bathrooms (including locker rooms and toilet rooms for employee use) are accessible.

Toilet Rooms and Bathrooms (cont'd)

Result:

People with disabilities are restricted to a limited number of toilet rooms and may have to travel long distances to the accessible toilet room while others can use any toilet room.

Requirement:

4.1.3(11) Toilet Facilities: If toilet rooms are provided, then each public and common use toilet room shall comply with 4.22. Other toilet rooms provided for the use of occupants of specific spaces (i.e., a private toilet room for the occupant of a private office) shall be adaptable. If bathing rooms are provided, then each public and common use bathroom shall comply with 4.23. Accessible toilet rooms and bathing facilities shall be on an accessible route.

Error/Omission:

Toilet rooms with 6 or more toilet stalls lack a 36" wide "ambulatory" toilet stall.

Result:

Too few accessible stalls are provided for people with mobility disabilities. People who walk with crutches, a cane, a walker, or who have limited balance generally find it easier and safer to use a stall that has parallel grab bars.

Requirement:

4.22.4, 4.23.4 Water Closets. If toilet stalls are provided, then at least one shall be a standard toilet stall complying with 4.17; where 6 or more stalls are provided, in addition to the stall complying with 4.17.3, at least one stall 36 in (915 mm) wide with an outward swinging, self-closing door and parallel grab bars complying with Fig. 30(d) and 4.26 shall be provided. Water closets in such stalls shall comply with 4.16. If water closets are not in stalls, then at least one shall comply with 4.16.

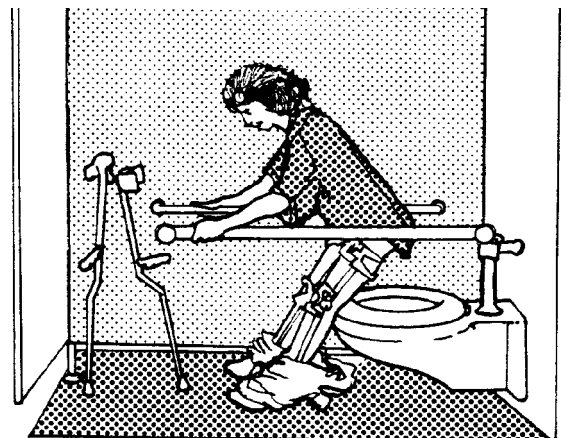

Error/Omission:

The door to the toilet room swings into the required clear floor space at accessible fixtures, controls, and dispensers.

Result:

The entry door to the toilet room cannot be fully opened when a wheelchair user is using the accessible fixture, control, or dispenser. For example, if a person using a wheelchair is positioned in the clear floor space at the paper towel dispenser and that clear floor space overlaps the space needed to swing the door open, the door cannot be fully opened.

Requirement:

4.22.3*, 4.23.3* Clear Floor Space. The accessible fixtures and controls required in 4.22.4, 4.22.5, 4.22.6, 4.22.7 and 4.23.4, 4.23.5, 4.23.6, and 4.23.7 shall be on an accessible route. An unobstructed turning space complying with 4.2.3 shall be provided within an accessible toilet room. The clear floor space at fixtures and controls, the accessible route, and the turning space may overlap.

Error/Omission:

When a transfer shower is used, it is often larger than the required 36" x 36" size.

Result:

People with disabilities may be injured when using a transfer shower that is too large. Users may slide off the seat and fall onto the floor of the shower while reaching for the shower controls and hand-held showerhead.

Requirement:

4.21.2 Size and Clearances. Except as specified in 9.1.2, shower stall size and clear floor space shall comply with Fig. 35(a) or (b). The shower stall in Fig. 35(a) shall be 36 in by 36 in (915 mm by 915 mm). Shower stalls required by 9.1.2 shall comply with Fig. 57(a) or (b). The shower stall in Fig. 35(b) will fit into the space required for a bathtub.

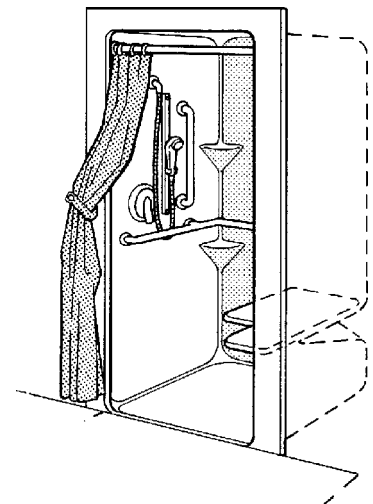
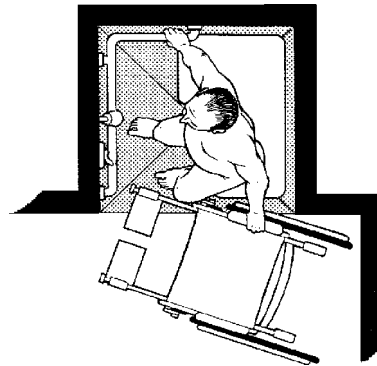

Signage

Error/Omission:

Where permanent room identification signage is provided, it is mounted in the wrong location.

Result:

People who are blind or visually impaired are trained to look in a consistent location for tactile signs. They cannot find the sign if it is not mounted in the correct location.

Requirement:

4.1.3(16)(a) Signs which designate permanent rooms and spaces shall comply with 4.30.1, 4.30.4, 4.30.5 and 4.30.6.

4.30.6 Mounting Location and Height. Where permanent identification is provided for rooms and spaces, signs shall be installed on the wall adjacent to the latch side of the door. Where there is no wall space to the latch side of the door, including at double leaf doors, signs shall be placed on the nearest adjacent wall. Mounting height shall be 60 in (1525 mm) above the finish floor to the centerline of the sign. Mounting location for such signage shall be so that a person may approach within 3 in (76 mm) of signage without encountering protruding objects or standing within the swing of a door.

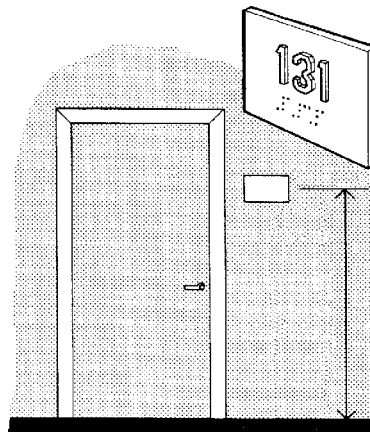

Visual Alarms

Error/Omission:

No visual alarms are provided although an audible alarm system is installed.

Result:

People who are deaf have no way of knowing that a building emergency has been declared while others who can hear are alerted by the audible alarm. This is especially true of toilet rooms, and study carrel areas where occupants cannot observe others leaving the facility.

Requirement:

4.1.3(14) If emergency warning systems are provided, then they shall include both audible alarms and visual alarms complying with 4.28. Sleeping accommodations required to comply with 9.3 shall have an alarm system complying with 4.28. Emergency warning systems in medical care facilities may be modified to suit standard health care alarm design practice.

Requirement:

4.28.1 General. Alarm systems required to be accessible by 4.1 shall comply with 4.28. At a minimum, visual signal appliances shall be provided in buildings and facilities in each of the following areas: restrooms and any other general usage areas (e.g., meeting rooms), hallways, lobbies, and any other area for common use.

Drinking Fountains

Error/Omission:

All drinking fountains are mounted with the spout at 36" A.F.F.

Result:

People who have difficulty stooping or bending over are not able to get a drink from the accessible 36" high drinking fountain.

Requirement:

4.1.3(10)* Drinking Fountains:

(a) Where only one drinking fountain is provided on a floor there shall be a drinking fountain which is accessible to individuals who use wheelchairs in accordance with 4.15 and one accessible to those who have difficulty bending or stooping. (This can be accommodated by the use of a "hi-lo" fountain; by providing one fountain accessible to those who use wheelchairs and one fountain at a standard height convenient for those who have difficulty bending; by providing a fountain accessible under 4.15 and a water cooler; or by such other means as would achieve the required accessibility for each group on each floor.)

(b) Where more than one drinking fountain or water cooler is provided on a floor, 50% of those provided shall comply with 4.15 and shall be on an accessible route.

Restaurants

Error/Omission:

Food service queuing areas are too narrow and do not provide adequate clear width for turns.

Result:

People who use wheelchairs cannot get to the counter to purchase or pick up food. Sometimes they get into the queuing area and get trapped.

Requirement:

4.3.3 Width. The minimum clear width of an accessible route shall be 36 in (915 mm) except at doors (see 4.13.5 and 4.13.6). If a person in a wheelchair must make a turn around an obstruction, the minimum clear width of the accessible route shall be as shown in Fig. 7(a) and (b).

Error/Omission:

Condiment or utensil items are placed above the reach range or are not located on an accessible route.

Result:

Wheelchair users cannot obtain condiments and other items because the items are out of reach or there is no way to get to the items.

Requirement:

5.6 Tableware and Condiment Areas. Self-service shelves and dispensing devices for tableware, dishware, condiments, food and beverages shall be installed to comply with 4.2 (see Fig. 54).

Transient Lodging

Error/Omission:

In hotels, motels, or other lodging facilities of 50 or more sleeping rooms, no rooms with roll-in showers are provided, or the roll-in showers that are provided lack a fold-down seat.

Result:

People who must use a roll-in shower or a shower with a fold-down seat cannot bathe. When a roll-in shower is provided without a folding seat, guests may resort to using guest room furniture in the shower.

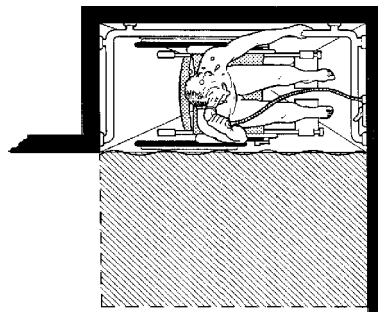

Requirement:

9.1.2 Accessible Units, Sleeping Rooms, and Suites. Accessible sleeping rooms or suites that comply with the requirements of 9.2 (Requirements for Accessible Units, Sleeping Rooms, and Suites) shall be provided in conformance with the table below. In addition, in hotels, of 50 or more sleeping rooms or suites, additional accessible sleeping rooms or suites that include a roll-in shower shall also be provided in conformance with the table below. Such accommodations shall comply with the requirements of 9.2, 4.21, and Figure 57(a) or (b).

Error/Omission:

Wheelchair-accessible rooms are not equipped with visual alarms and notification devices.

Result:

People who are deaf or hard of hearing and who also need to use a guest room with accessible features have no accommodation.

Requirement:

9.2.2 (8) Sleeping room accommodations for persons with hearing impairments required by 9.1 and complying with 9.3 shall be provided in the accessible room or suite.

Error/Omission:

Doors into and within guest rooms that are not accessible guest rooms do not provide at least 32" clear opening width.

Result:

People who use a wheelchair, scooter, or walker are unable to enter standard guest rooms and are excluded from accommodations when accessible guestrooms are occupied.

Requirement:

9.4 Other Sleeping Rooms and Suites. Doors and doorways designed to allow passage into and within all sleeping units or other covered units shall comply with 4.13.5.

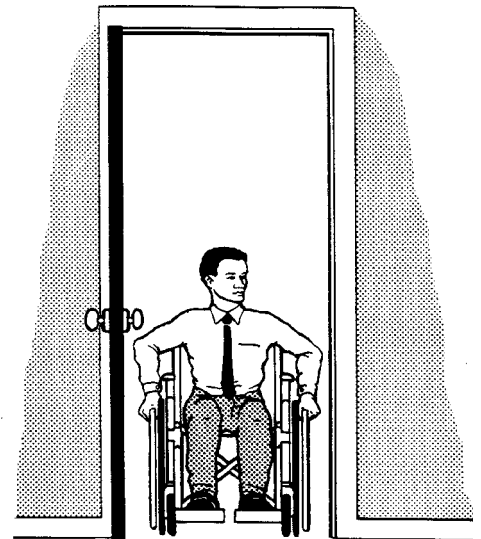



Common ADA Problems at Newly Constructed Lodging Facilities

Introduction

Hotels, motels, inns, and other places of lodging designed and constructed after January 26, 1993 must comply with the Americans with Disabilities Act (ADA). To comply with the ADA and to make it possible for persons with disabilities to use lodging facilities like everyone else, lodging facilities must meet specific requirements set out in Justice Department regulations, 28 C.F.R. pt. 36. These regulations include detailed architectural requirements known as the ADA Standards for Accessible Design (ADA Standards), 28 C.F.R. pt. 36, Appendix A. The ADA Standards are designed to make lodging facilities usable by persons with a wide variety of disabilities, including persons who are blind or who have low vision, persons who are deaf or hard of hearing, persons with mobility impairments who use wheelchairs, canes, crutches, or walkers, and persons with other disabilities or with combinations of disabilities.

The Justice Department is the government agency responsible for enforcing the ADA at lodging facilities. As part of ADA enforcement efforts, the Department has conducted numerous on-site investigations of hotels, motels, inns, and other places of lodging. During these investigations, the Department has observed certain common ADA problems at newly constructed lodging facilities. This publication describes those problems so that owners, franchisors, architects, and building contractors can avoid these common ADA mistakes and comply with the law when designing and constructing new facilities. This document is not intended to be comprehensive or exhaustive. Any failure to comply with the ADA Standards violates the ADA.

For additional information about the design and construction requirements of the ADA, contact the Department of Justice ADA Information Line. This free service provides answers to general and technical questions about ADA requirements and is a source for free ADA materials including the ADA Standards for Accessible Design, "Five Steps to Make New Lodging Facilities Comply with the ADA," and "ADA Checklist for Newly Constructed Lodging Facilities," and "Common ADA Errors and Omissions in New Construction and Alterations." You may reach the ADA Information Line at: 800-514-0301 (voice) or 800-514-0383 (TTY). ADA information is also available on the Department's ADA Home Page on the World Wide Web at (<http://www.usdoj.gov/crt/ada/adahom1.htm>).

**Reproduction of this document
is encouraged.**

Guestroom Doors

Common Problem:

Doors and doorways into and within all guestrooms and suites, including bathroom doors and doorways, do not allow 32 inches of clear opening width.

Result:

Doors and doorways into and within guestrooms and suites and, in particular, bathroom doors and doorways within these spaces are too narrow to allow persons who use wheelchairs, crutches, walkers, and other mobility aids to pass through them. As a result, persons with disabilities are excluded from accommodations when accessible guestrooms are sold out and also are unable to visit other guests in their rooms.

Requirements:

All doors and doorways (except shallow closets) into and within all guestrooms and suites (including guestroom bathrooms, kitchens, and connecting room doors) shall provide 32 inches of clear opening width measured when a hinged door is open 90 degrees or a sliding door is fully opened.

ADA Standards 9.4; 4.13.5.

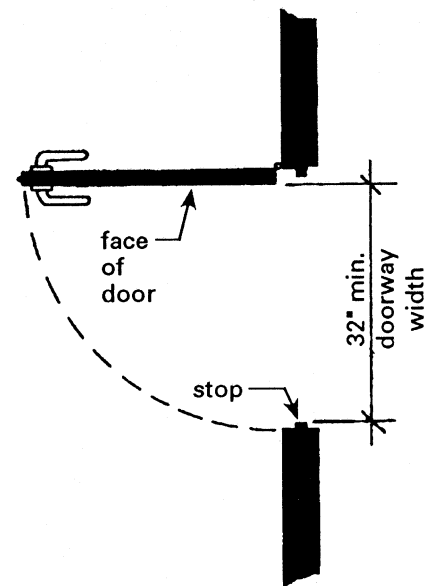
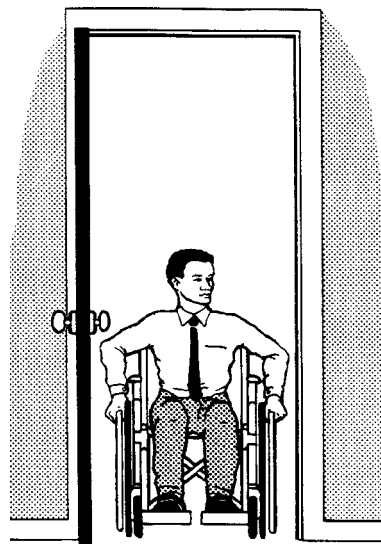

Measuring Clear Width

Guestroom Types and Features

Common Problem:

Accessible guestrooms are not dispersed among the various classes of rooms available at a lodging facility and do not provide people with disabilities the same range of amenities available to others.

Result:

Persons with disabilities who desire or may need different classes of accessible guestrooms are denied the range of lodging options that other guests without disabilities can take for granted (e.g., rooms with one or two beds, suites).

Requirements:

In order to provide persons with disabilities the same range of options that are available to other persons at the facility, lodging facilities must disperse accessible guestrooms/suites among the various classes of guestrooms/suites available at the facility. Factors to be considered in dispersing accessible guestrooms among different classes of rooms include room size, cost, amenities provided (e.g., smoking and nonsmoking rooms, suites, kitchenettes, rooms with preferred views, connecting rooms), and the number of beds provided. ADA Standards 9.1.4.

Accessible Guestroom Choices	
Rooms with One Bed	✓
Rooms with Two Beds	✓
Suites	✓
Smoking and Nonsmoking Rooms	✓

Guestrooms with Roll-in Showers

Common Problem:

In hotels, motels, or other lodging facilities of 50 or more sleeping rooms, no rooms with roll-in showers are provided, or the roll-in showers that are provided lack a permanently attached fold-down seat.

Result:

Some people with mobility impairments, such as persons who use wheelchairs, walkers, crutches, and other mobility aids, must use a roll-in shower or a shower with a fold-down seat in order to shower.

When a roll-in shower is not provided or when the roll-in shower lacks a folding seat, these guests may not be able to shower or may resort to using guestroom furniture in the shower.

Requirements:

Lodging facilities must provide a specific number of accessible guest rooms based on the table provided below. Bathing facilities in these rooms must comply with the Standards. In addition, in lodging facilities with more than 50 guestrooms or suites, the facility must provide a specified number of accessible guestrooms that have a roll-in shower with a permanently attached fold-down seat. The roll-in shower in these rooms must comply with specific requirements contained in Figure 57 of the Standards, shown on this page.

ADA Standards 9.1.2; 9.2; 4.21; Figure 57(a) or (b).

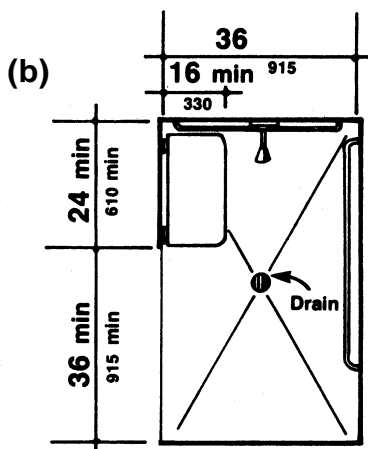
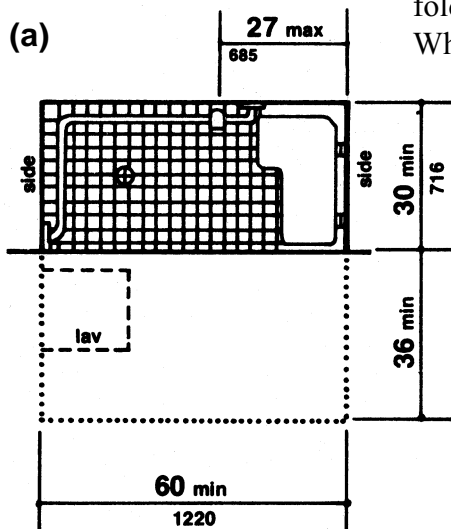

Fig. 57
Roll-in Shower
with Folding Seat

<u>Total Guestrooms</u>	<u>Required Accessible Guestrooms</u>
1 to 25	1
26 to 50	2
51 to 75	4 (1 with roll-in shower)
76 to 100	5 (1 with roll-in shower)
101 to 150	7 (2 with roll-in showers)
151 to 200	8 (2 with roll-in showers)
201 to 300	10 (3 with roll-in showers)
301 to 400	12 (4 with roll-in showers)
401 to 500	13 (4 with roll-in showers)
501 to 1000	2% of all rooms (plus 1 room with a roll-in shower for each 100 rooms)
1001 and over	20 plus 1 for each 100 over 1000 (plus 1 room with a roll-in shower for each 100 rooms)

Visual Alarms

Common Problem:

Accessible guestrooms and suites (and an additional number of rooms specifically for individuals who are deaf or hard of hearing) are not equipped with visual alarms and other visual notification devices.

Result:

People who are deaf or hard of hearing cannot hear fire alarms, ringing telephones, knocking at doors or ringing doorbells. Consequently, when accessible guestrooms and other guestrooms do not have visual fire alarms and visual notification devices, people who are deaf or hard of hearing have no notice of fires or other life-threatening emergencies and have no means of knowing when the telephone is ringing, when someone is knocking on the door, or when someone is ringing the doorbell.

Requirements:

All accessible guestrooms and a specific number of additional guestrooms for use by persons who are deaf or hard of hearing must be equipped with visual fire alarm strobes that are connected to the building's fire alarm system and visual notification devices to alert guests who are deaf or hard of hearing to telephone calls and to persons knocking on the door and/or ringing the doorbell. While visual alarms must be connected to the fire alarm system, notification devices (for doors and telephones) may be provided in kits available at the lodging facility's registration desk. In addition to accessible guestrooms, lodging facilities must provide additional guestrooms for persons who are deaf or hard of hearing following the table on this page. ADA Standards 9.1.3; 9.2.2 (8); 9.3; 9.3.2.

<u>Total Guestrooms</u>	<u>Guestrooms for Use by Persons Who Are Deaf or Hard of Hearing*</u>
1 to 25	1
26 to 50	2
51 to 75	3
76 to 100	4
101 to 150	5
151 to 200	6
201 to 300	7
301 to 400	8
401 to 500	9
501 to 1000	2% of all rooms
1001 and over	20 plus 1 for each 100 over 1000

*Rooms for persons who are deaf or hard of hearing are required in addition to accessible guestrooms.

Operating Hardware

Common Problem:

The shape of the hardware on accessible doors, and on faucets, fixed lamps, drapery controls, and heating and air conditioning controls in spaces required to be accessible requires tight grasping, pinching, and twisting of the wrist.

Result:

Persons who have the use of only one hand or who have limited use of hands, wrists, or arms are unable to open doors to get into rooms, lock doors for security, use sinks or showers to wash, adjust draperies for privacy, turn on lamps, or adjust heating or air conditioning levels for comfort.

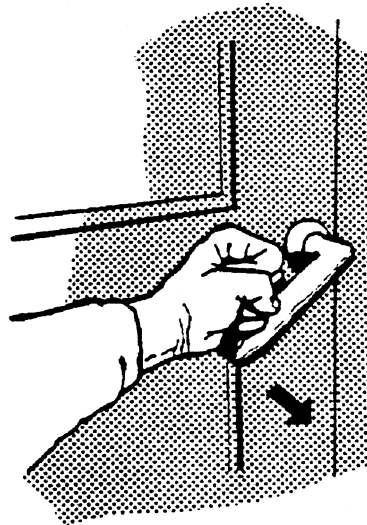

Requirements:

Handles, pulls, latches, locks, and other operating devices on accessible doors; faucets; fixed lamps; and drapery, heating, and air conditioning controls shall have a shape that is easy to grasp with one hand and does not require tight grasping, tight pinching, or twisting of the wrist to operate. Lever-operated mechanisms, push-type mechanisms, and U-shaped handles are acceptable designs. ADA Standards 4.13.9; 9.2.2(3); 9.2.2(5).

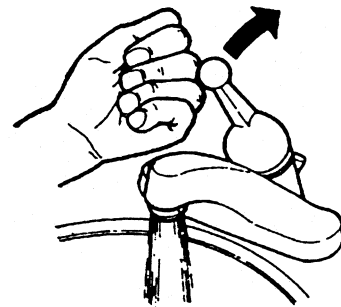

single-lever handle that is easy to reach and operable with one hand

Signage

Common Problem:

For permanent rooms and spaces, identification signage is mounted in the wrong location and cannot be read by persons who are blind or have low vision.

Result:

Blind persons and persons with low vision will have difficulty locating rooms. If Braille and raised letter signs are mounted on doors instead of walls, blind persons and persons with low vision may be hurt by someone who is pushing a door open while they are trying to read a sign or they may not be able to find the sign.

Requirements:

Signs that are provided for all permanent rooms and spaces in the lodging facility must be mounted on the wall (not the door) adjacent to the latch side of the door and centered 60 inches above the floor so that they can be easily located by persons who are blind or who have low vision. Signs must include the same information in Braille, with raised lettering that forms a high contrast with the background of the sign. Signs should not be made of reflective materials such as brass, silver, gold, glass, or mirrored surfaces unless there is an additional properly located sign that complies with the Standards. ADA Standards 4.1.3(16)(a); 4.30.4; 4.30.5.

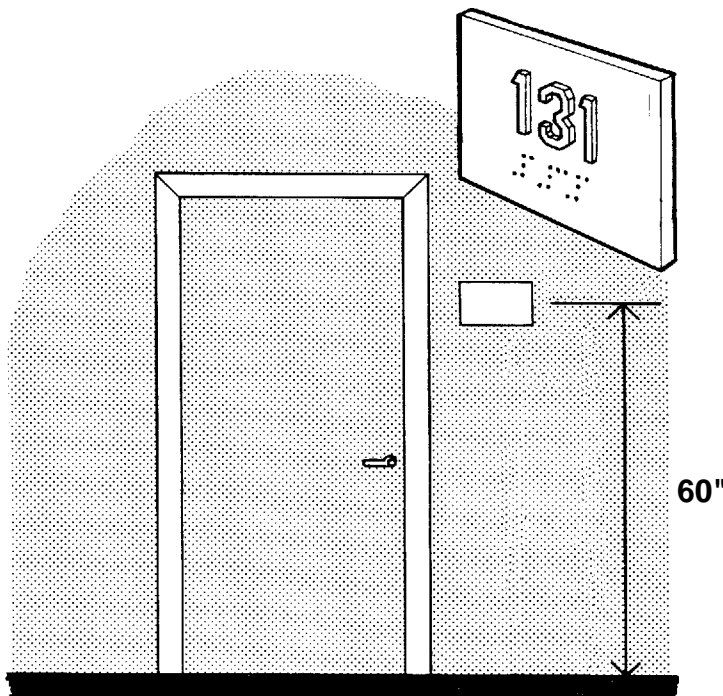

Accessible Routes -- Interior and Exterior

Common Problem:

Both the exterior pedestrian routes (e.g., sidewalks, walkways and plazas) on a site that people use to travel from public transportation stops, from accessible parking spaces, from passenger loading zones, and from public streets and sidewalks to the accessible entrance(s), and the interior routes (e.g., hallways and corridors) throughout the lodging facility, are not usable by persons who use wheelchairs or other mobility aids, or who are unable to climb steps or stairs.

Result:

Because people who use wheelchairs, walkers, scooters or other mobility aids cannot climb steps or negotiate curbs, people with disabilities are often unable to travel safely into the lodging facility from public transportation, parking lots, passenger drop-off areas, and public streets and sidewalks without using a vehicular way. Once inside the lodging facility, people with disabilities cannot get through the facility to the guestrooms, conference rooms, toilet rooms, restaurants, or other various accessible elements and spaces.

At least one route that is a minimum of 36 inches wide without steps, stairs, or other abrupt level changes must be provided

Requirements:

At least one route that is a minimum of 36 inches wide without steps, stairs, or other abrupt level changes must be provided within the boundary of the lodging facility's property from an accessible entrance to the building to public transportation stops, accessible parking spaces, accessible passenger pick-up/drop-off areas, if provided, and public streets or sidewalks. Once inside the facility, an accessible route must be provided between an accessible entrance, lobby and the various accessible elements and spaces in the lodging facility. ADA Standards 4.1.2 (1); 4.1.3(1); 4.3.

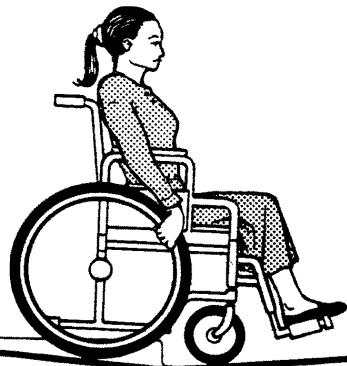
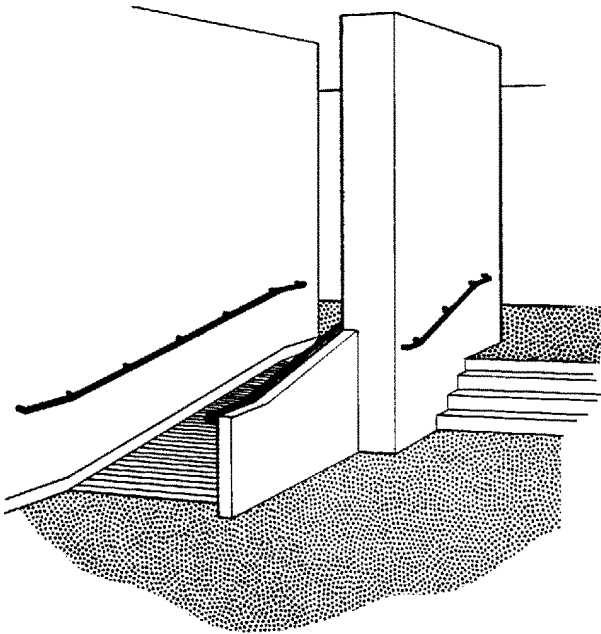

Protruding Objects

Common Problem:

In areas inside and outside the lodging facility where people are expected to walk, objects protrude too far from the side, from posts, or hang down too low from overhead.

Result:

People who are blind or who have low vision can be seriously injured when they are unable to detect an object in their path by using the sweep of their cane.



Requirements:

All objects that protrude from surfaces or posts and all overhanging objects in areas where people walk shall comply with the following requirements:

Objects mounted on walls at a height above 27 inches and below 80 inches (e.g., fire extinguishers, telephones) shall protrude no more than 4 inches into walks, halls, corridors, passageways, aisles, or any other areas where a person walks.

Free-standing objects mounted on posts or pylons may not project more than 12 inches into walks, halls, corridors, passageways, aisles, or any other area where a person walks at heights between 27 inches and 80 inches above the ground or finished floor.

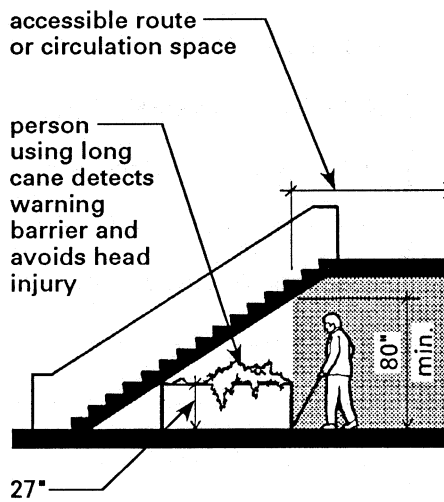

Stairways and escalators with undersides that are not enclosed and all objects hanging above walks, hallways, corridors, passageways, aisles, and lobbies cannot hang down below a height of 80 inches above the ground or finished floor, unless there is a cane-detectible barrier that would alert a person who is blind or who has low vision to the hazard.

ADA Standards 4.1.2(3); 4.1.3(2); 4.4.

Elevators

Common Problem:

Lodging facilities with more than two floors of occupiable space -- including any basement levels -- do not have full-size passenger elevators available for use by guests.

Result:

People with disabilities who are unable to use stairs and steps cannot gain access to floors above and below the ground level and, in many instances, do not have access to the amenities provided in the lodging facility.

Requirements:

At least one passenger elevator must serve each level of a facility that has more than two floors of occupiable space, including basement levels. If a facility has less than 3,000 square feet per floor, an elevator exemption applies. All passenger elevators must meet the requirements of the Standards.

ADA Standards 4.1.3(5); 4.10.

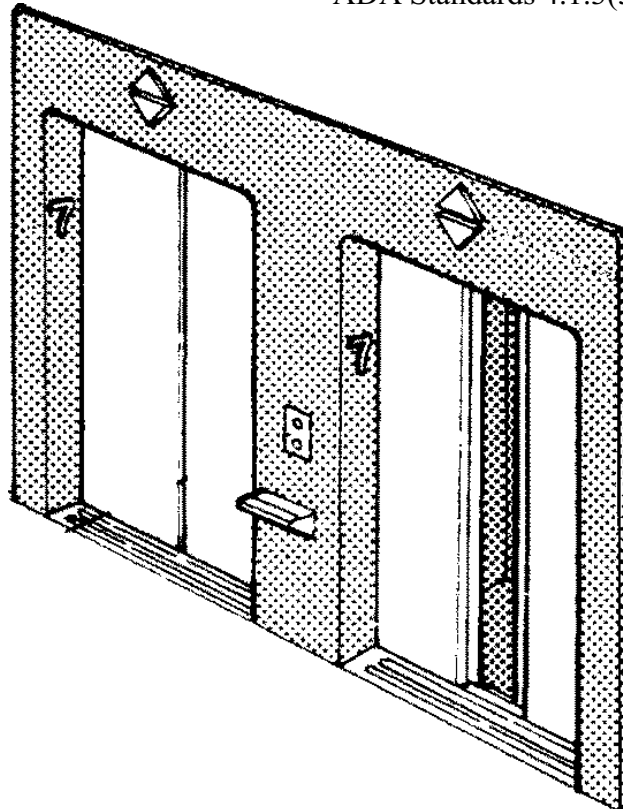

Common Problem:

There are an insufficient number of accessible parking spaces provided, including van-accessible parking spaces, in the proper locations.

Result:

Persons with disabilities are unable to park their vehicles and do not have convenient access to

the lodging facility. Persons who use vans equipped with a wheelchair lift have inadequate space to lower the lift and exit the vehicle.

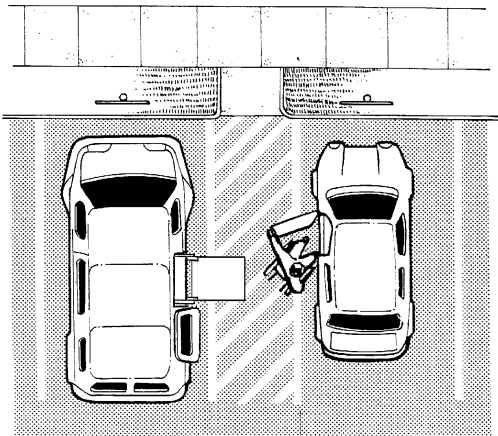

Requirements:

When a lodging facility offers “self-parking,” it must have the proper number of standard accessible parking spaces and van-accessible parking spaces as shown in the table below. Standard accessible parking spaces must be at least 8 feet wide and have or share an access aisle that is at least 5 feet wide. Van-accessible spaces must be at least 8 feet wide and have or share an access aisle that is at least 8 feet wide. The vertical clearance for van accessible parking spaces shall be at least 98 inches. The surface of all standard accessible parking spaces and all van-accessible parking spaces should be level (i.e., no greater than 1:50 or 2%). Accessible parking spaces should be dispersed so that some of those spaces are the nearest to the lobby and others are the nearest spaces to accessible entrances that serve accessible guestrooms. All accessible spaces in a parking garage may be grouped on one level of the structure. All accessible parking spaces must have signs with the international symbol of accessibility that are mounted high enough so that they are not obscured by parked cars. ADA Standards 4.1.2 (5); 4.6.2; 4.6.3; 4.6.4.

<u>Total Spaces in Parking Lot</u>	<u>Required Number of Accessible Parking Spaces</u>
1 to 25	1 van space
26 to 50	1 standard space + 1 van space
51 to 75	2 standard spaces + 1 van space
76 to 100	3 standard spaces + 1 van space
101 to 150	4 standard spaces + 1 van space
151 to 200	5 standard spaces + 1 van space
201 to 300	6 standard spaces + 1 van space
301 to 400	7 standard spaces + 1 van space
401 to 500	7 standard spaces + 2 van spaces
501 to 1000	2 % of total spaces; 1 in every 8 accessible spaces must be van-accessible
1001 and over	20 + 1 extra space for each hundred spaces over 1000; 1 in every 8 accessible spaces must be van-accessible